

# MATERIALI DIGITALI



**U.d.A. Insieme in inverno**

**Schede di coding**

**Modello berretto e guanti**

**Il libro della spremuta colorato**

**Il calendario dell'avvento**

**La calza della Befana**

**Un simpatico pagliaccio**



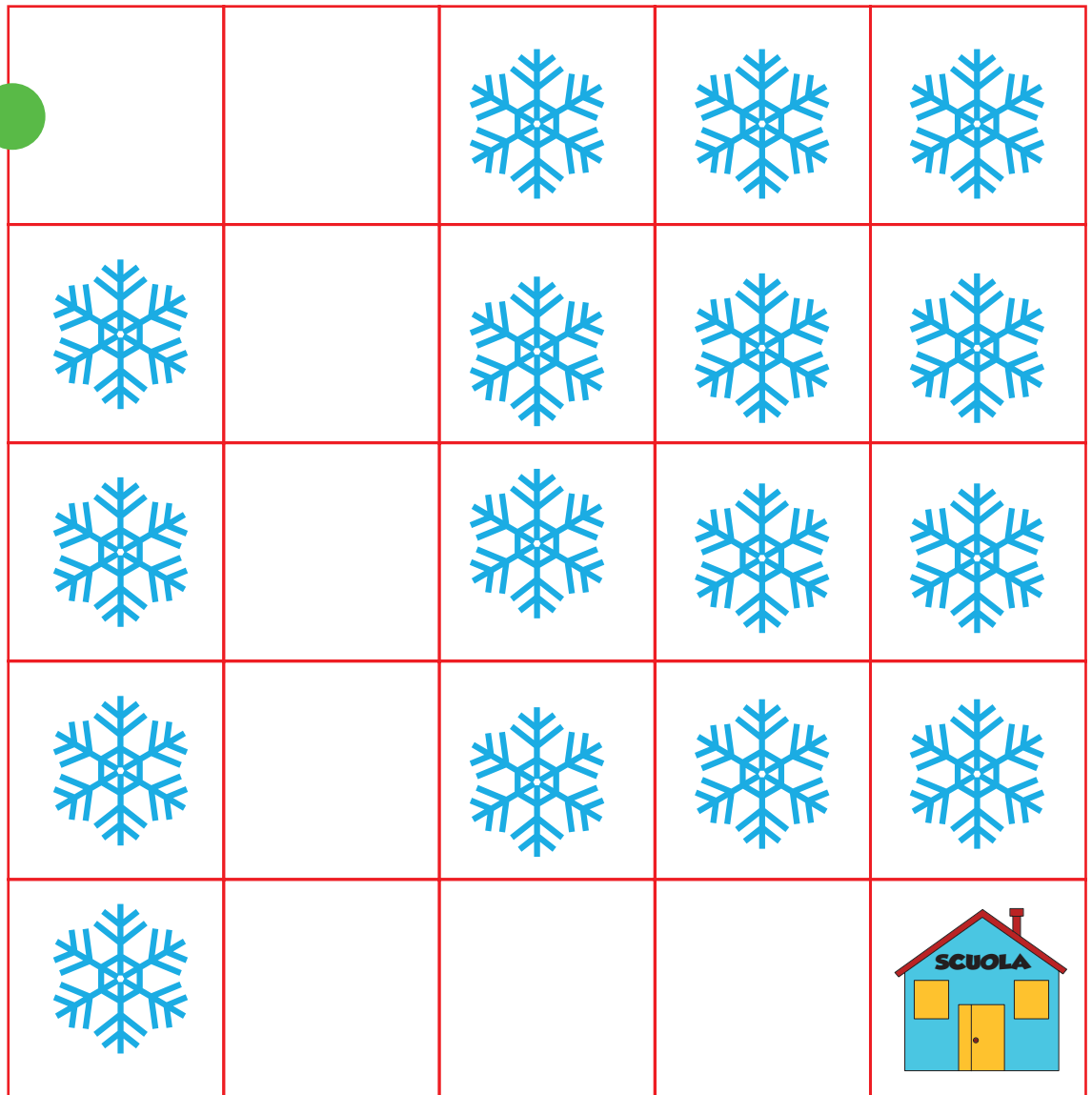
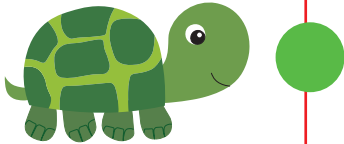



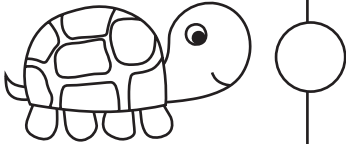

# IL CODING DELL'INVERNO

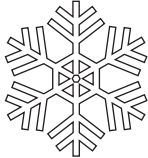
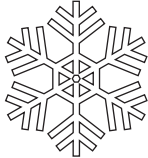
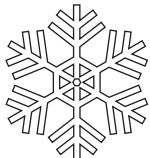
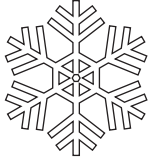

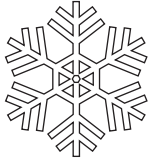
RIPASSA CON L'INDICE IL PERCORSO CHE DEVE FARE LA TARTARUGA LIA PER ARRIVARE A SCUOLA CAMMINANDO SUL SENTIERO SENZA TOCCARE LA NEVE.

# IL CODING DELL'INVERNO

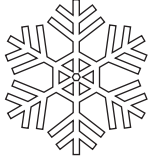
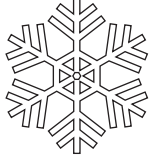

DISEGNA IL PERCORSO CHE DEVE FARE LA TARTARUGA LIA PER ARRIVARE A SCUOLA SENZA TOCCARE LA NEVE.

## IL BERRETTO

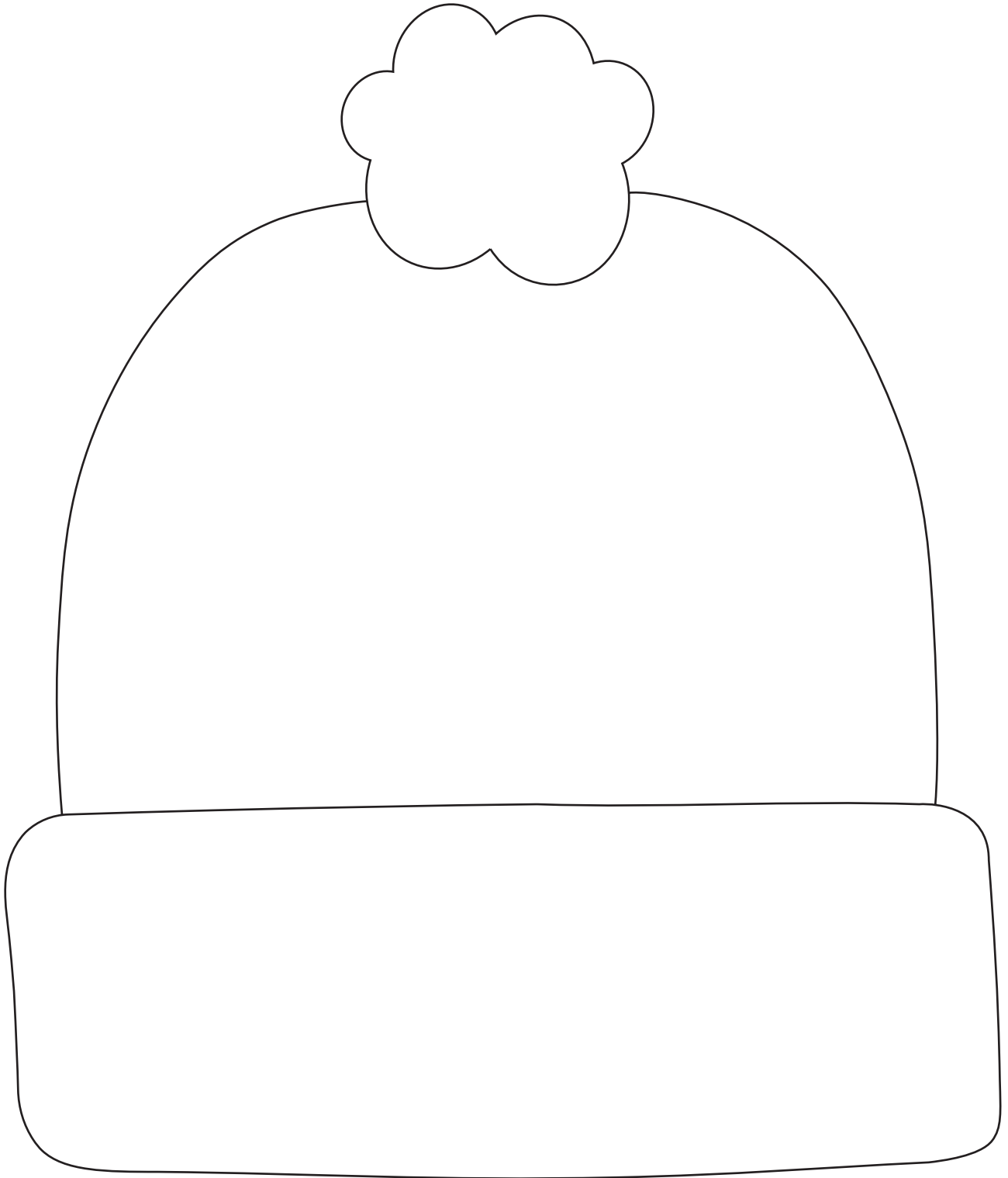

DIPINGI TANTI PUNTINI SUL BERRETTO CON IL COTTON FIOC E I COLORI A TEMPERA.

# I GUANTI

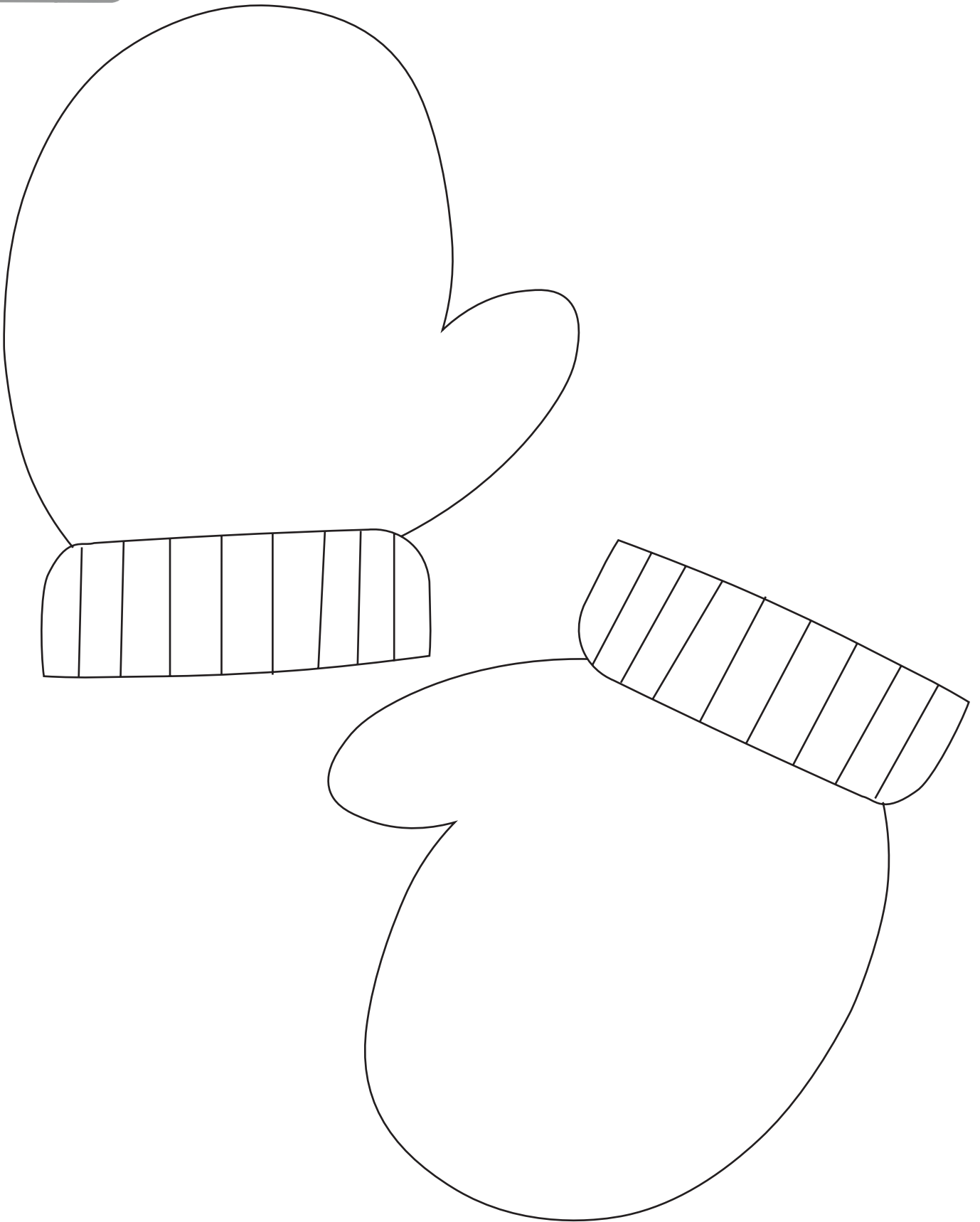

DIPINGI TANTI PUNTINI SUI GUANTI CON IL COTTON FIOC E I COLORI A TEMPERA.

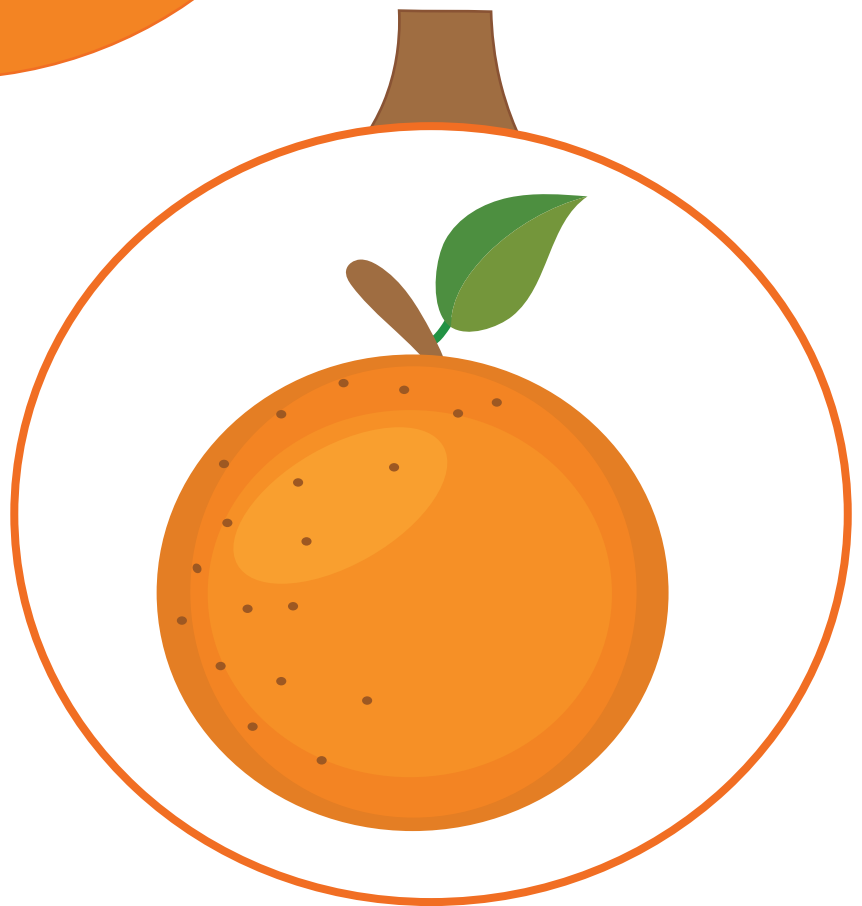

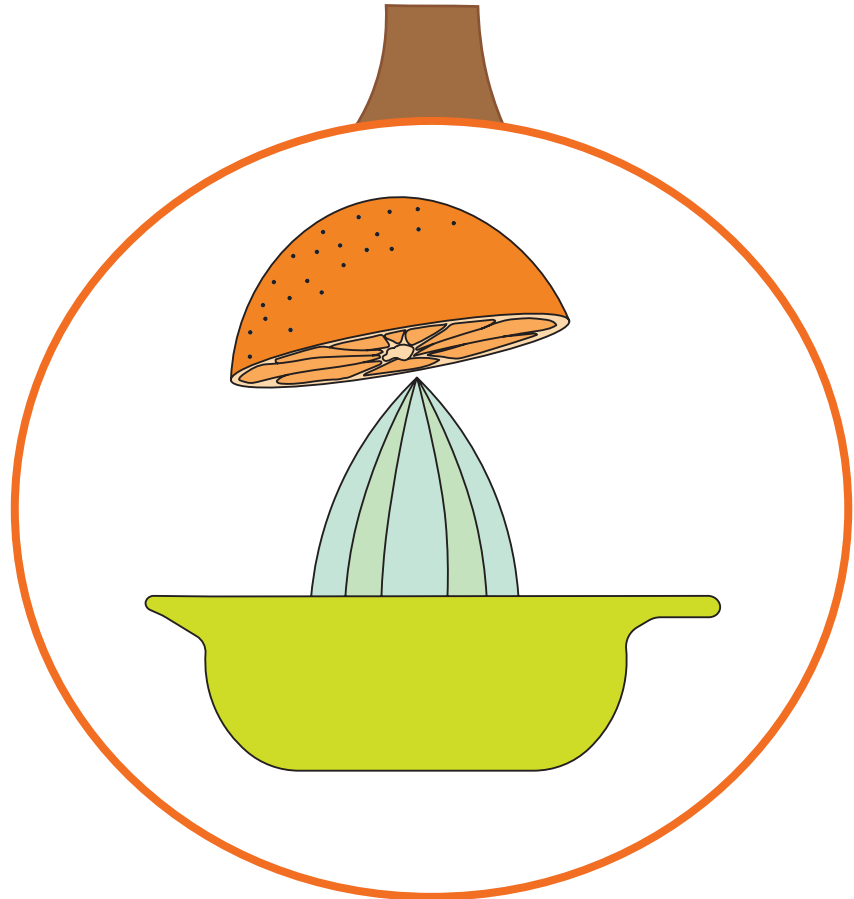
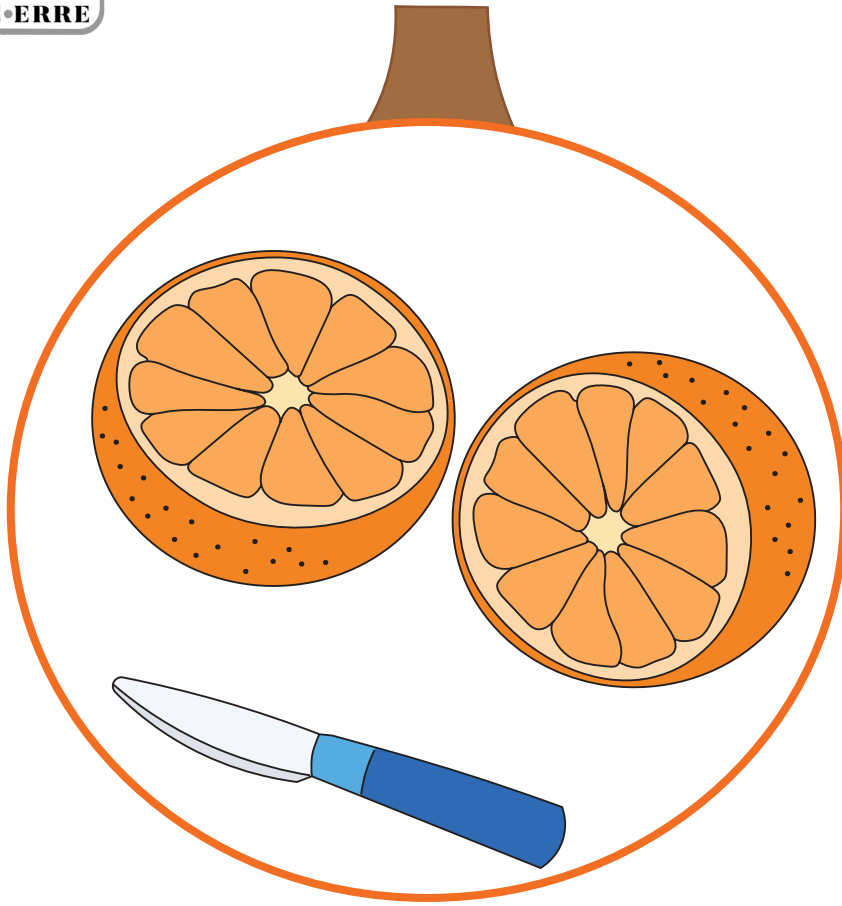

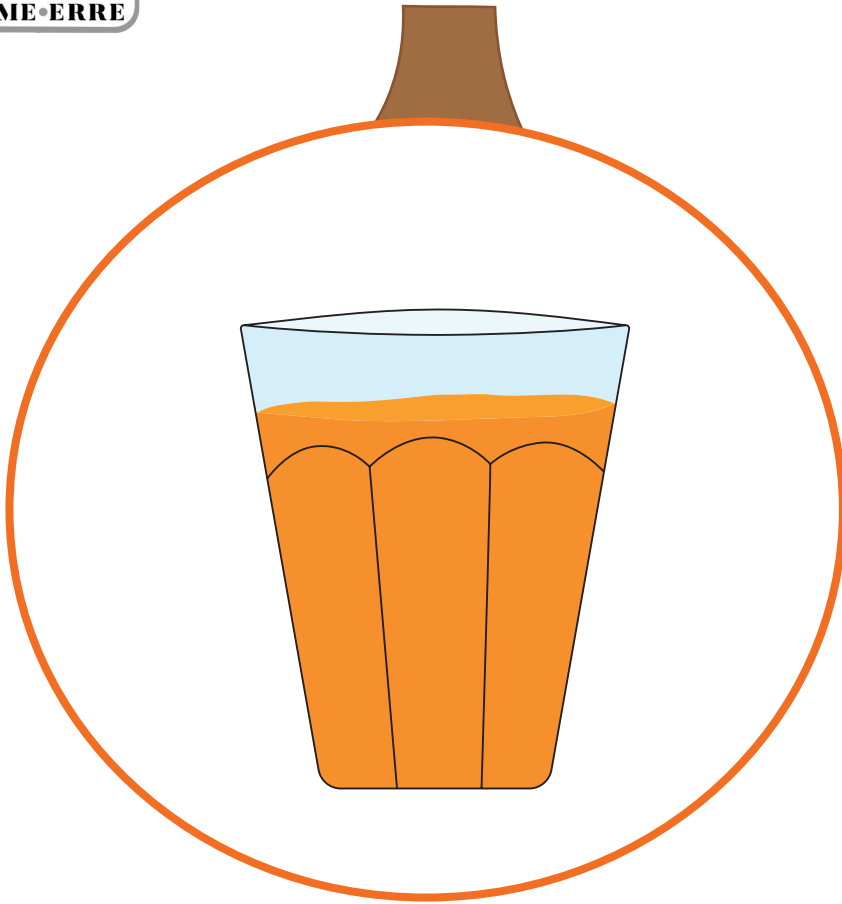

**C'è un frutto speciale  
che è proprio eccezionale,  
ha una vitamina assai preziosa  
che è davvero portentosa.  
Inizia bene ogni mattina  
con una bella spremutina,  
le arance mettono allegria,  
mangiale anche in compagnia!**

**Rita Sabatini  
fantavolando.it**



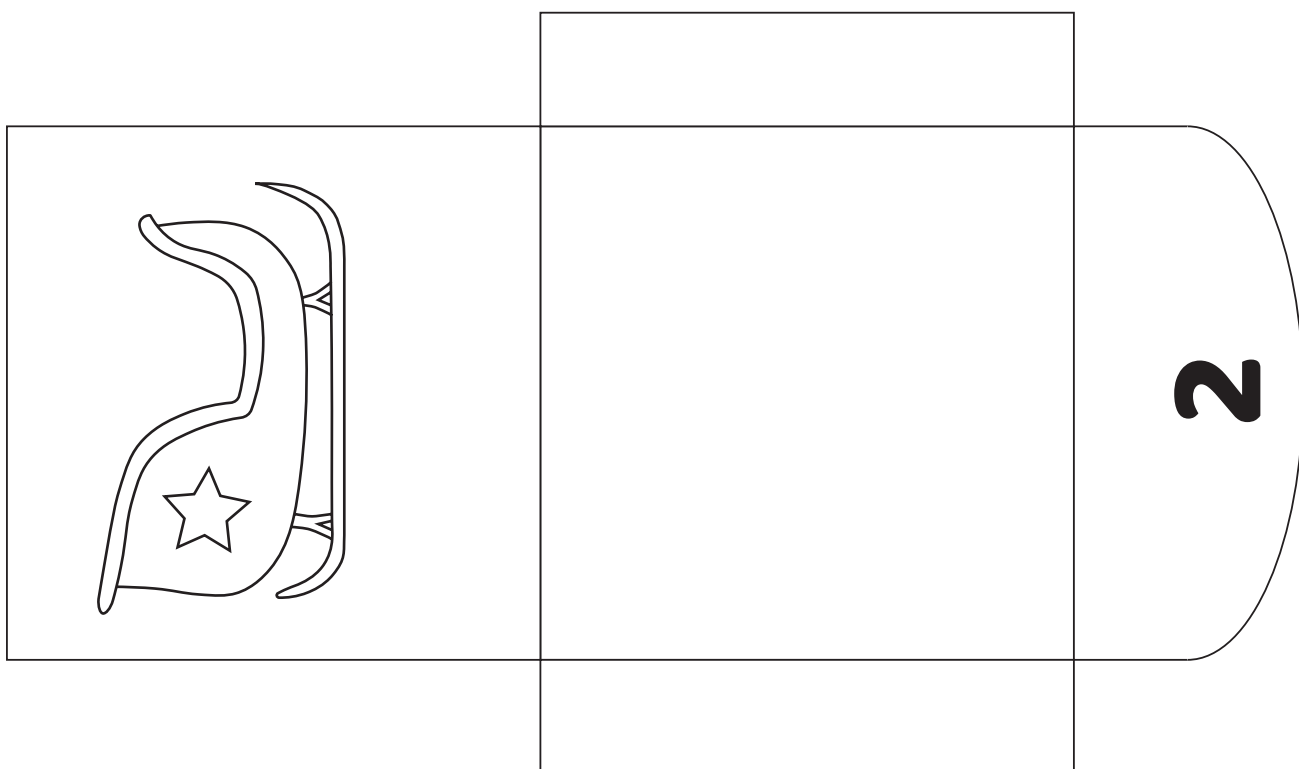
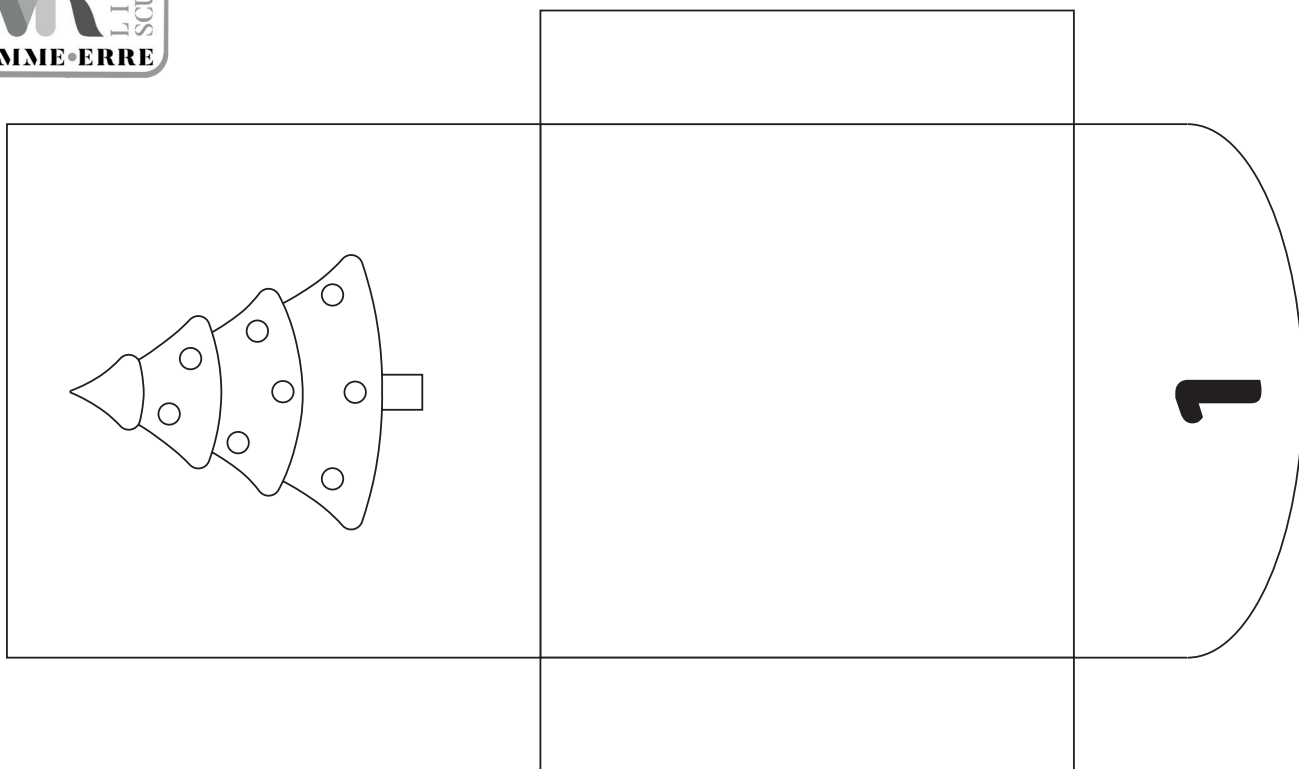

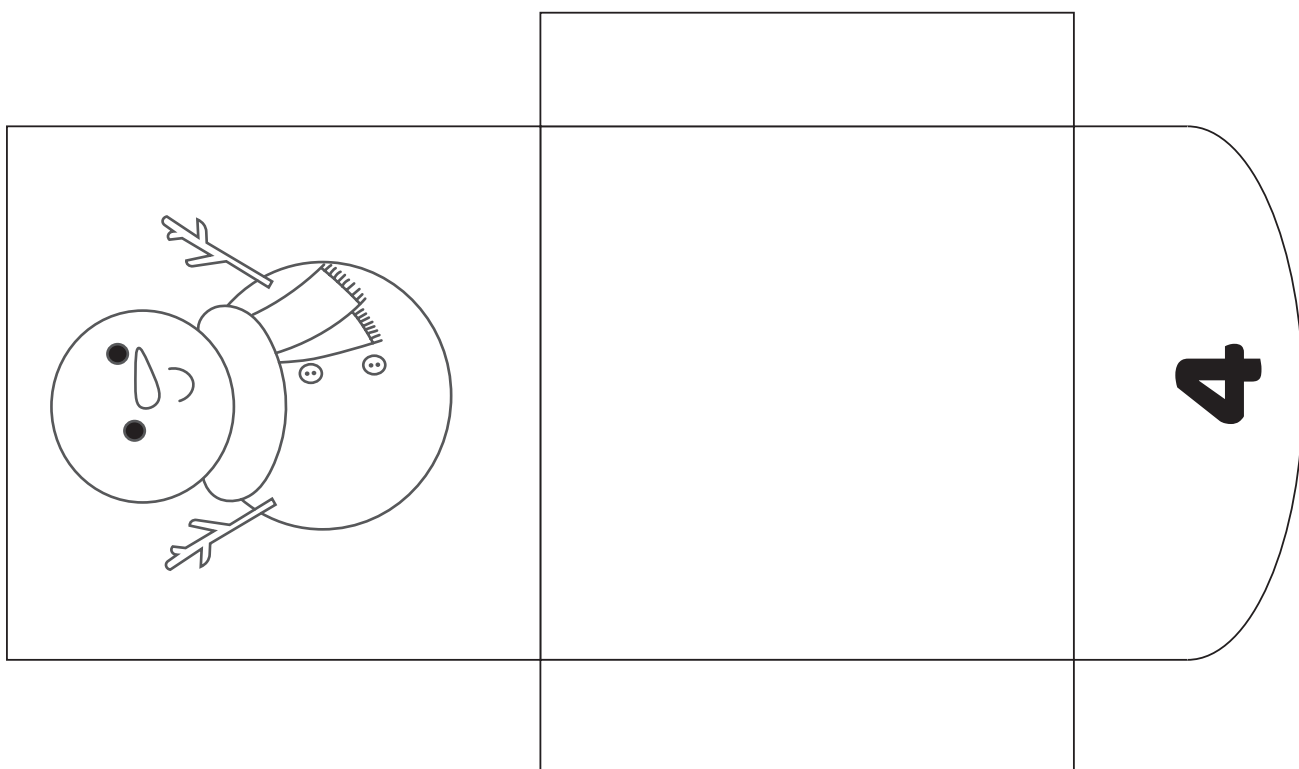
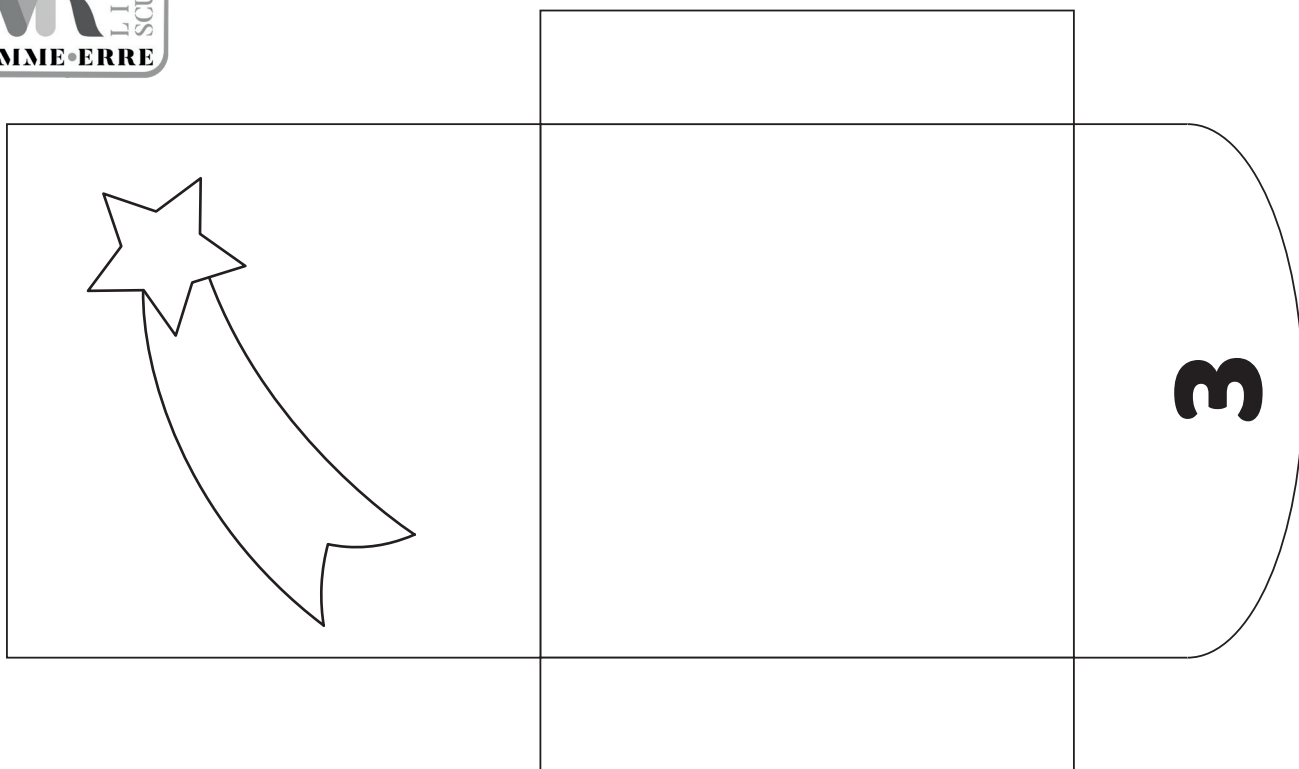

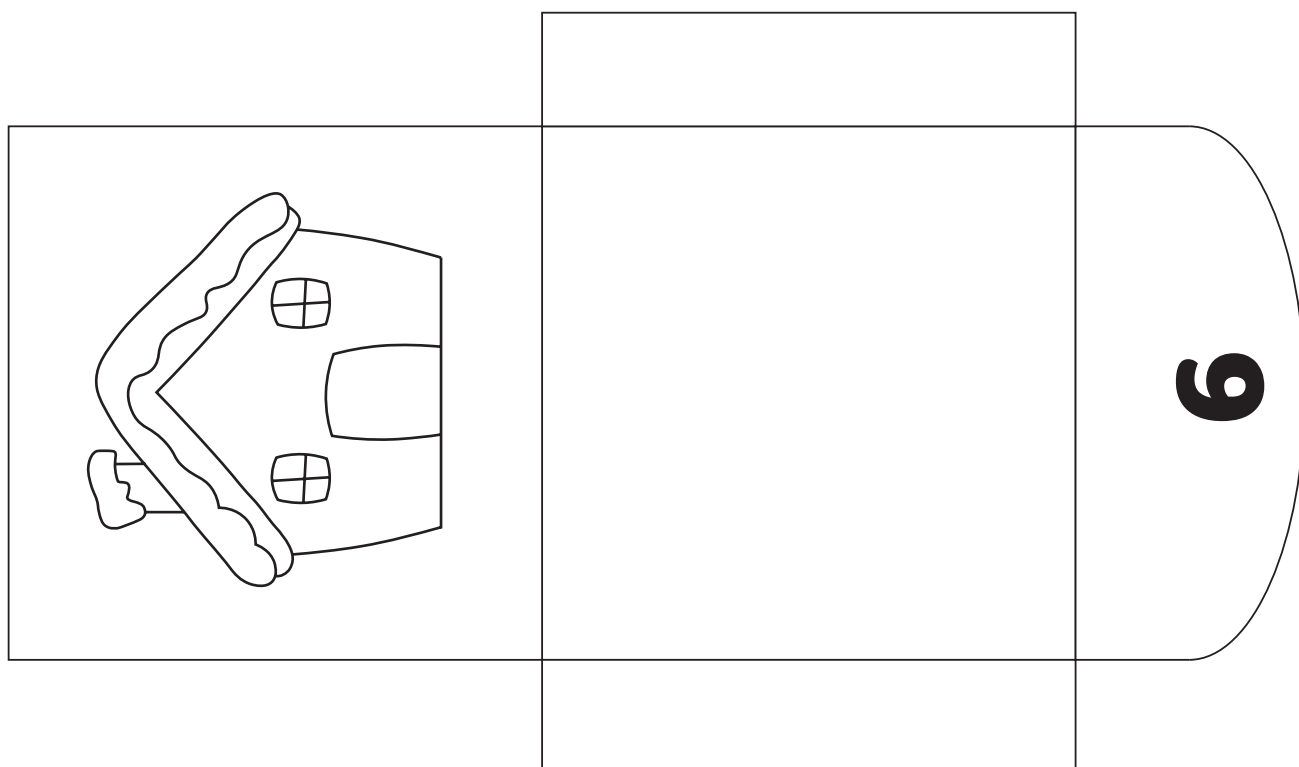
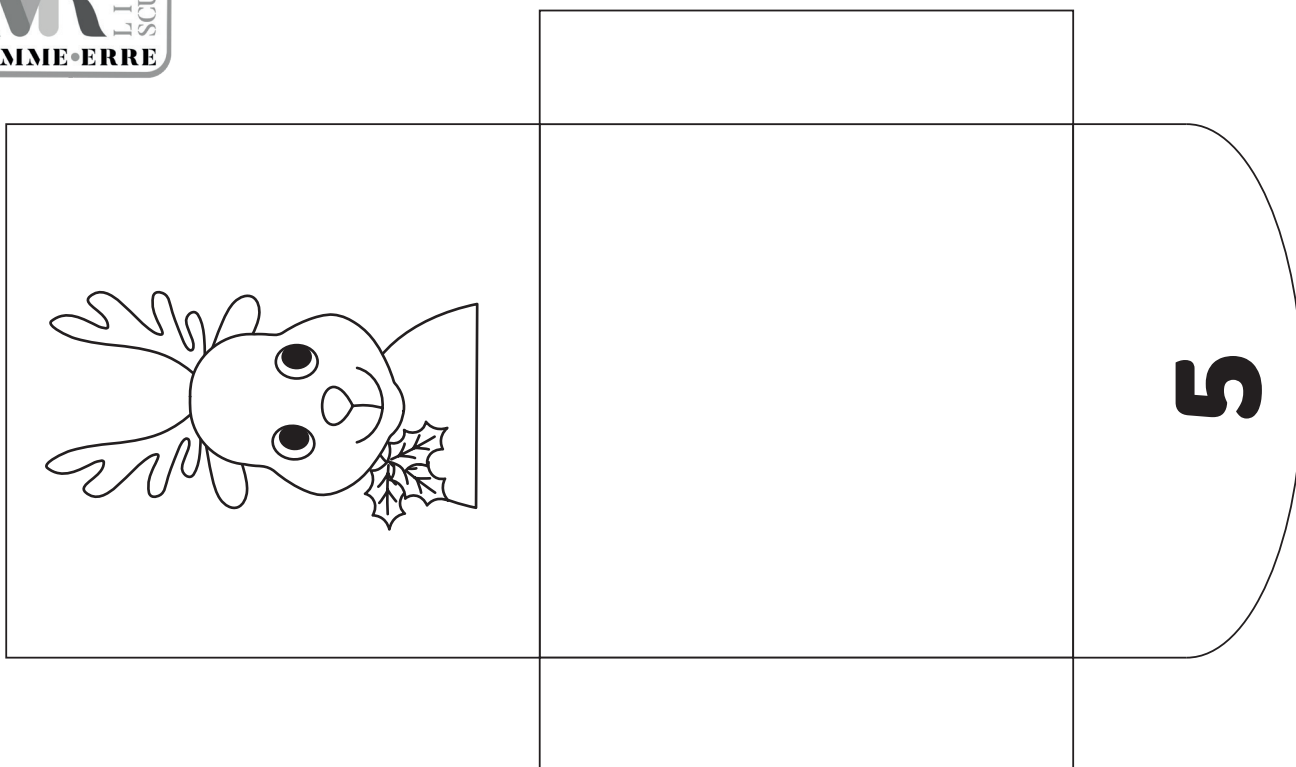

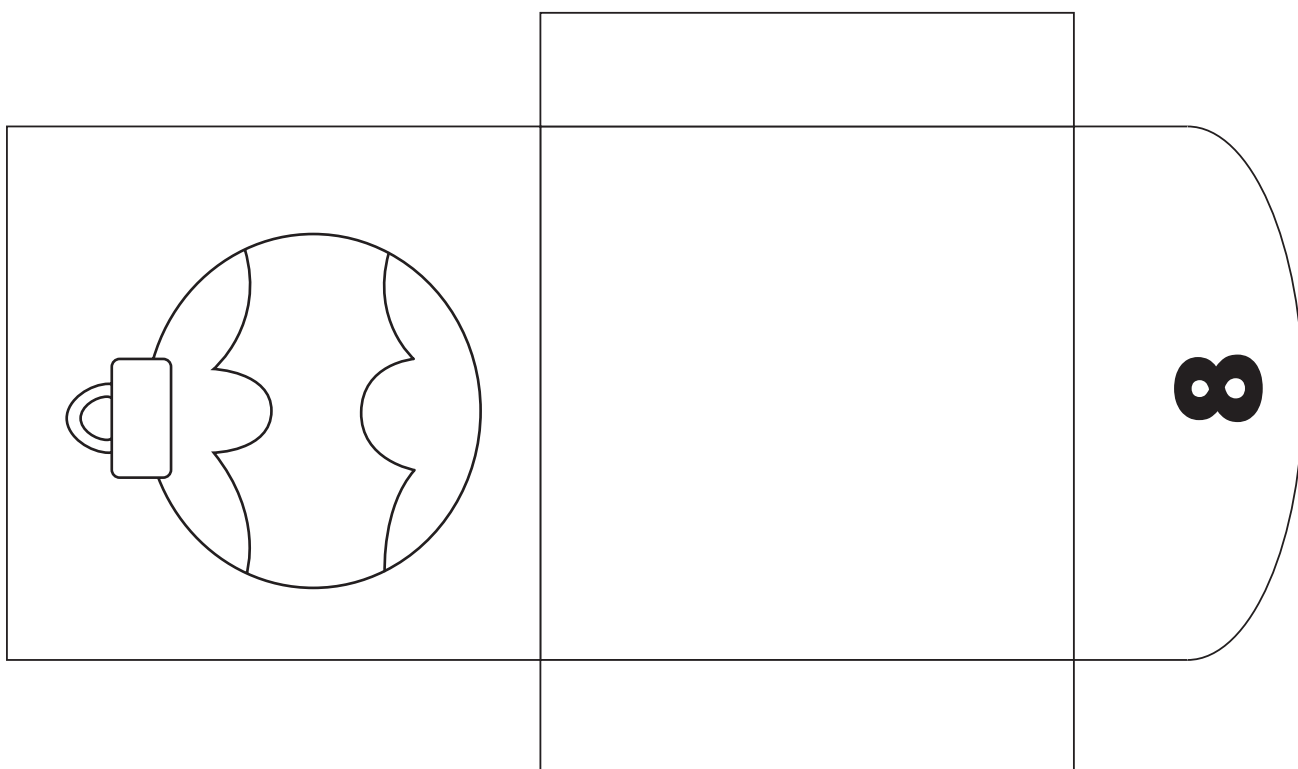
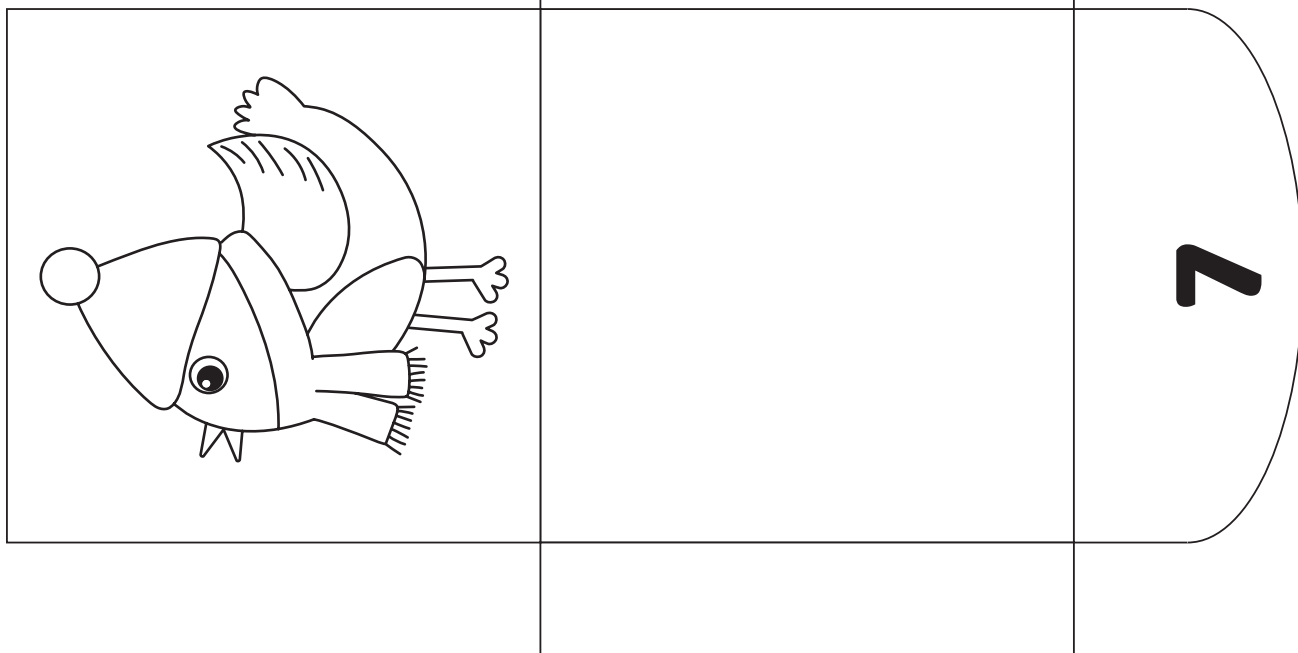

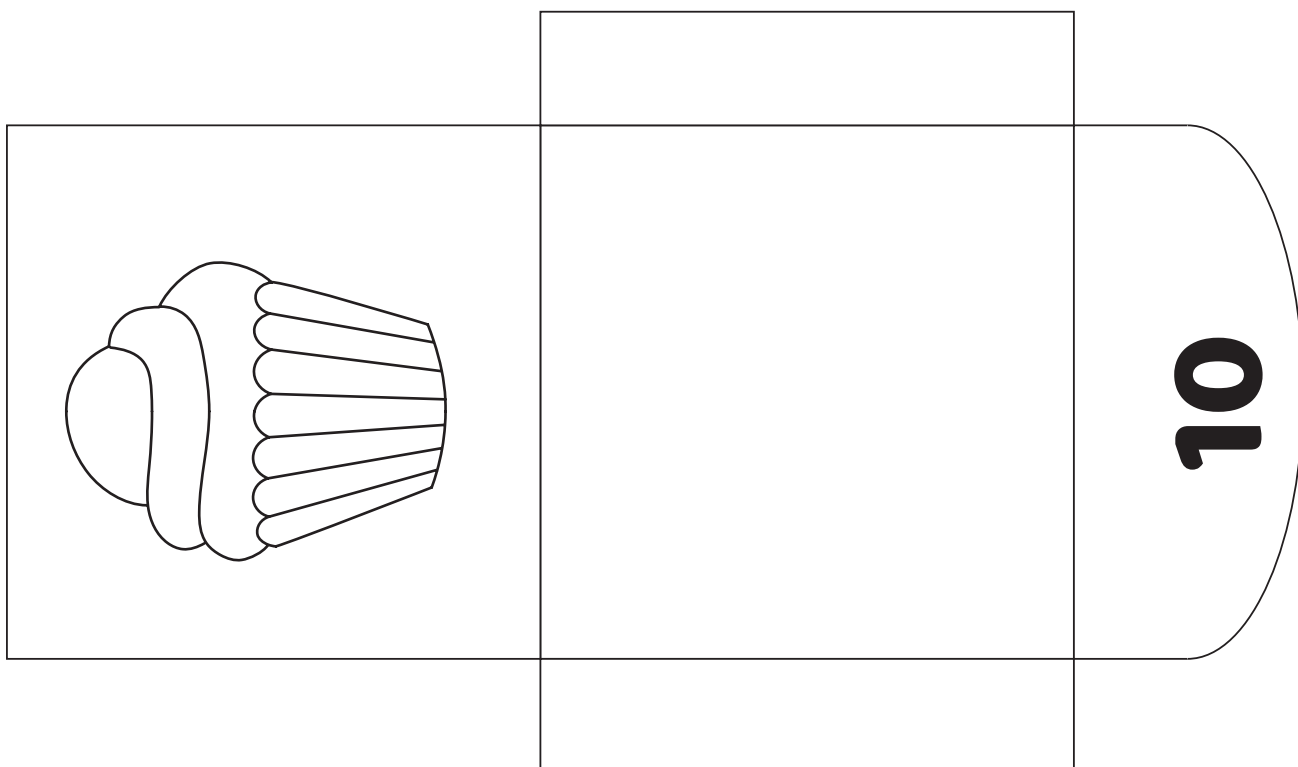
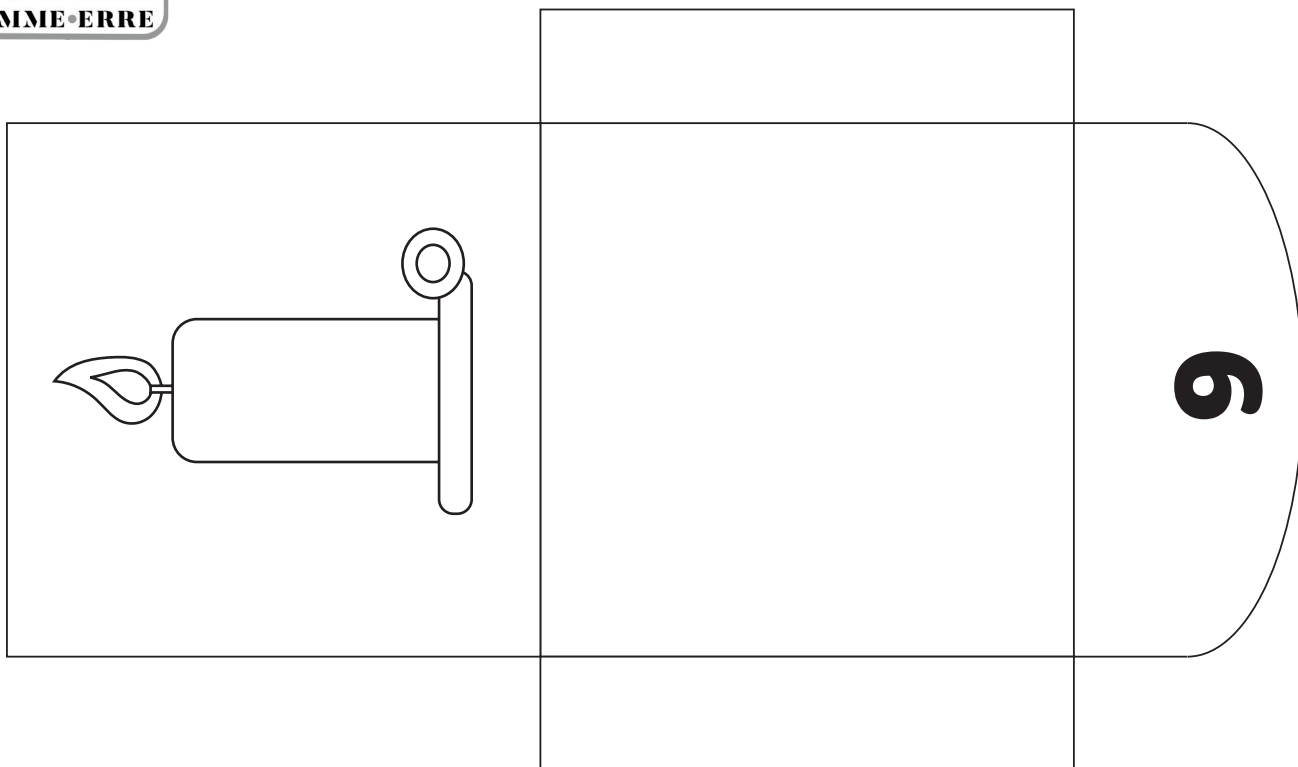

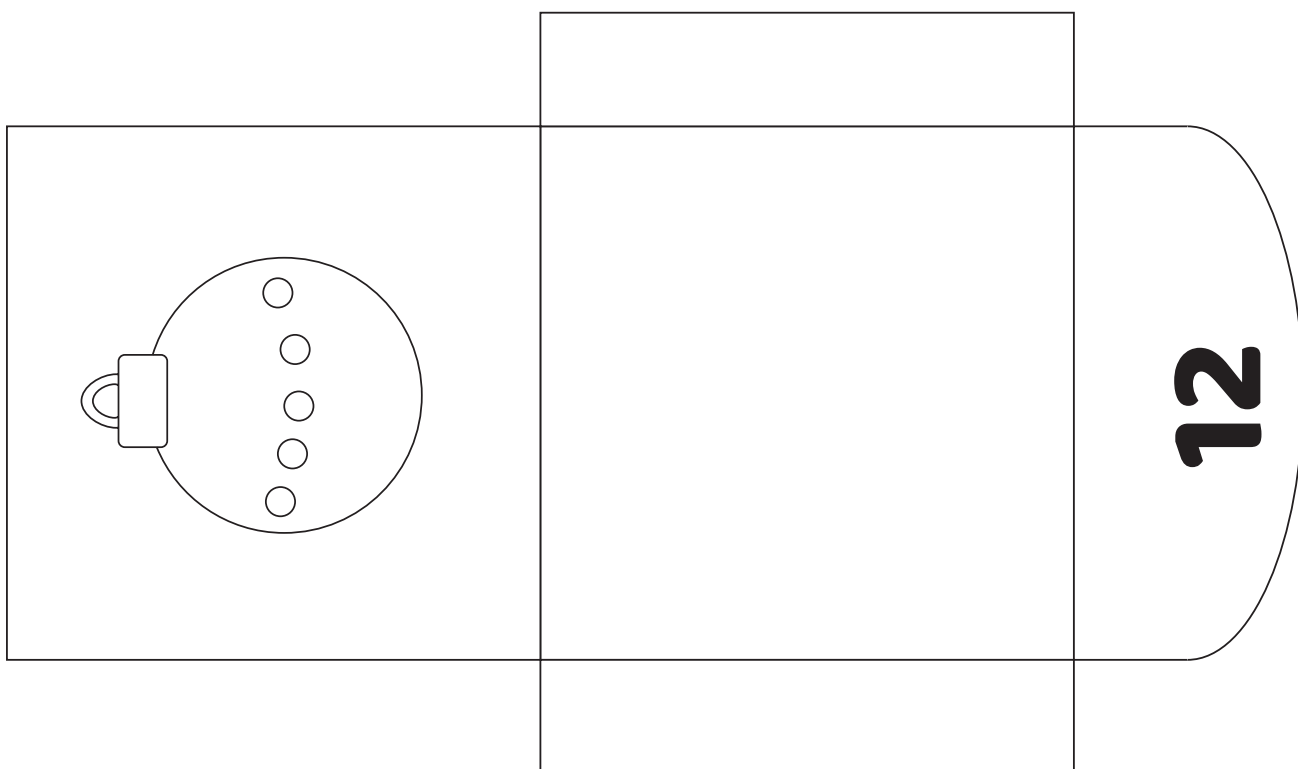
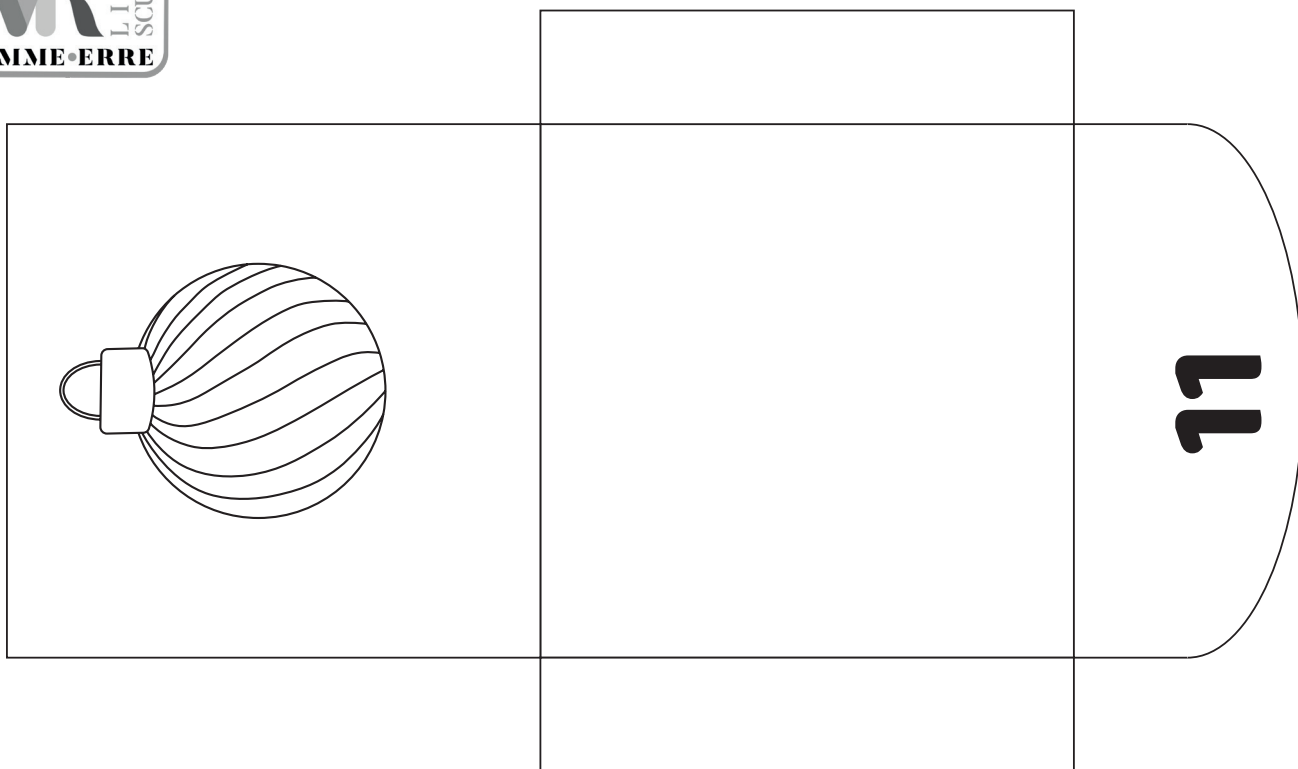

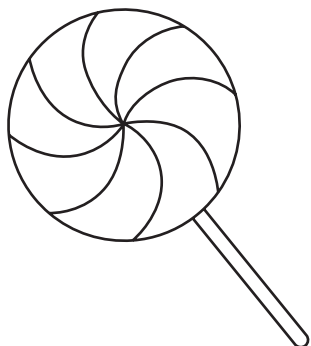

**13**

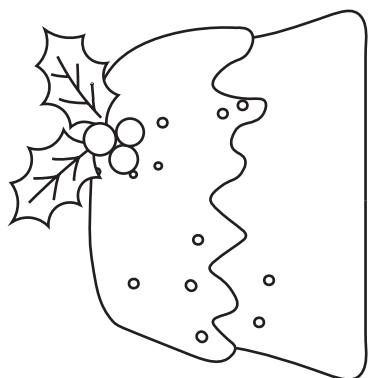

**14**

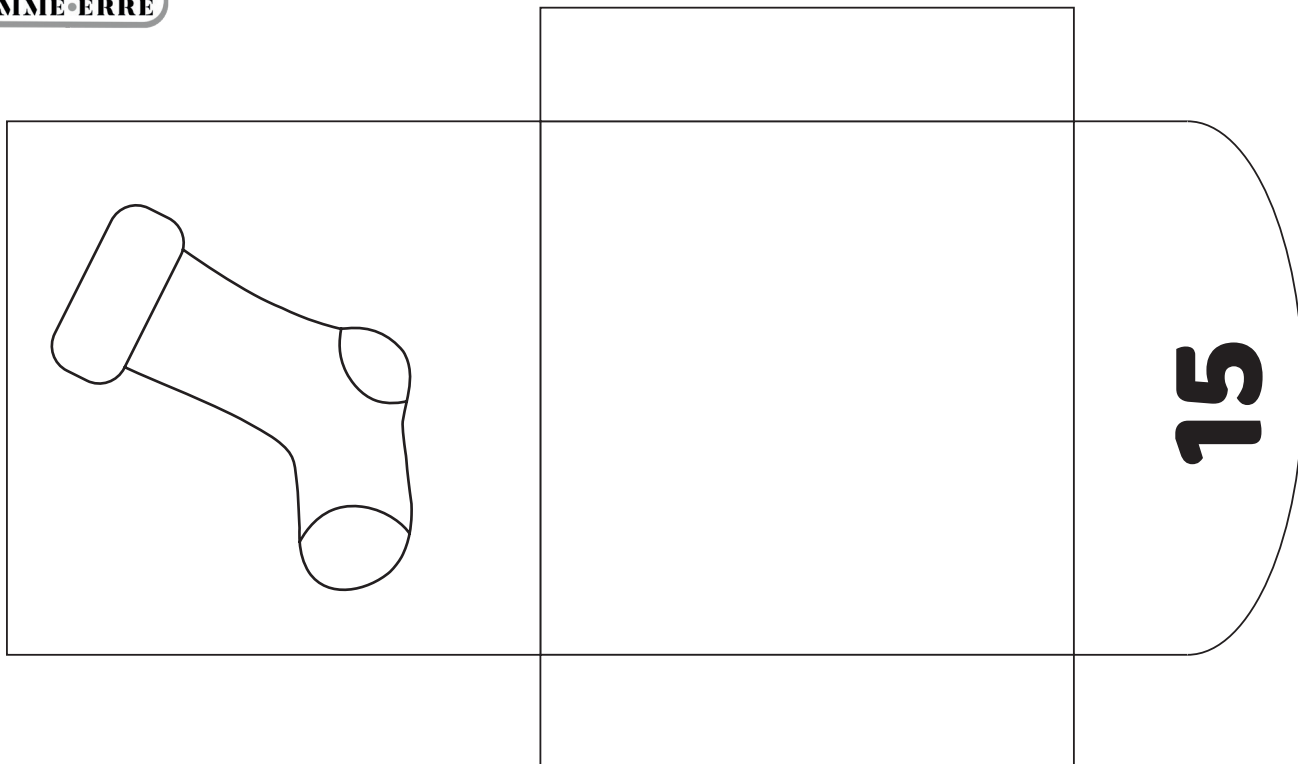

**15**

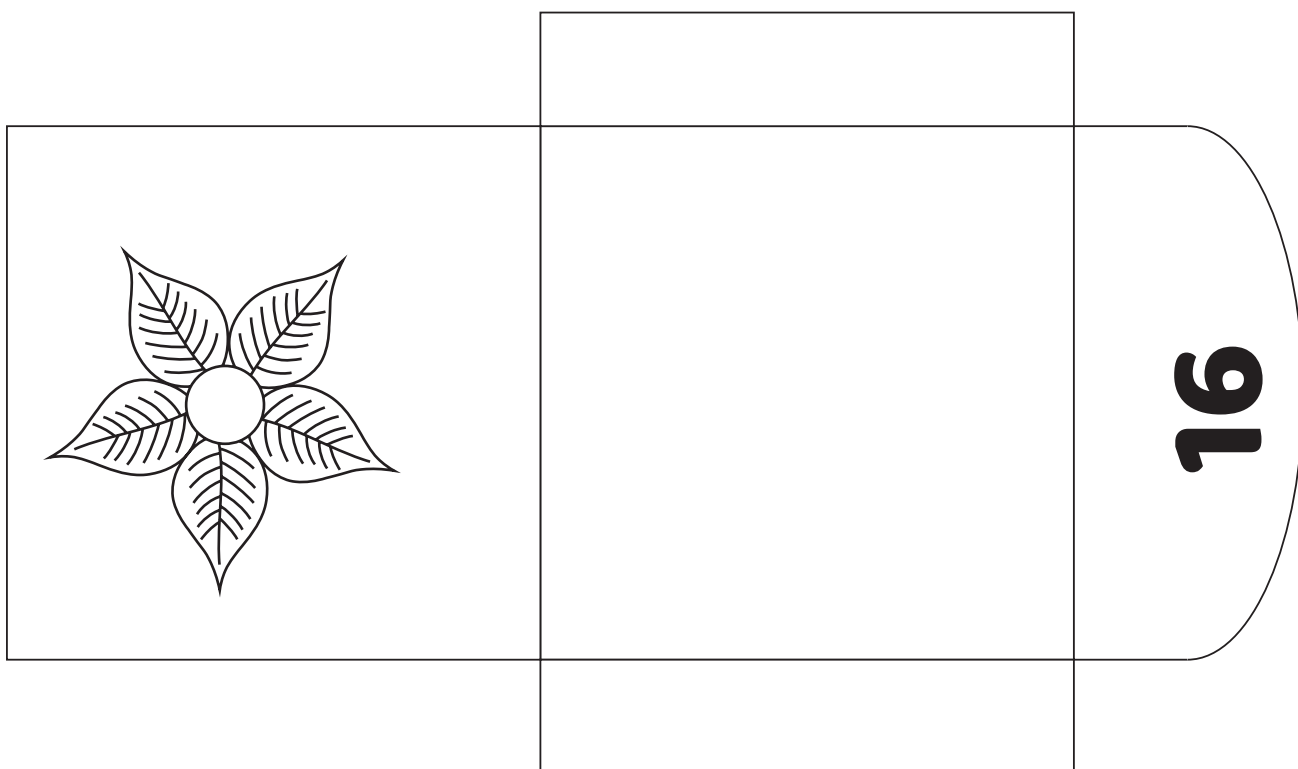

**16**



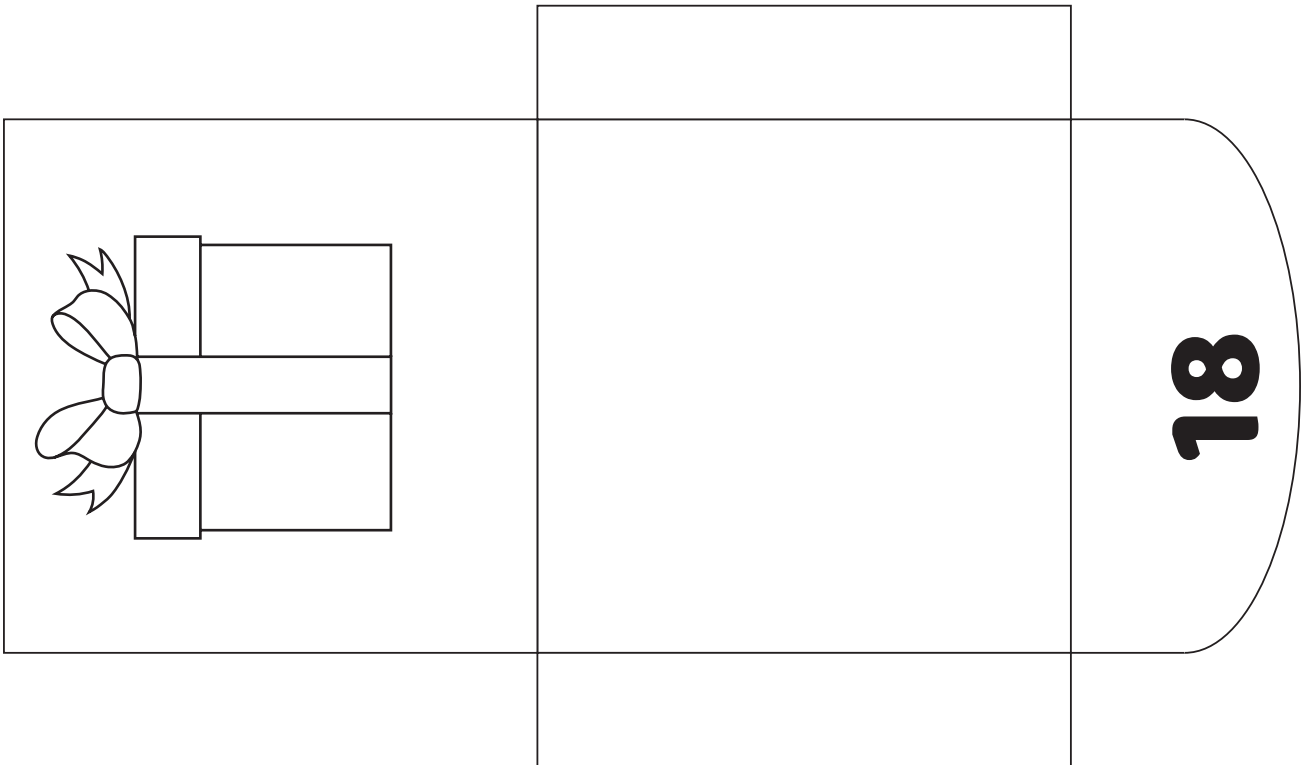
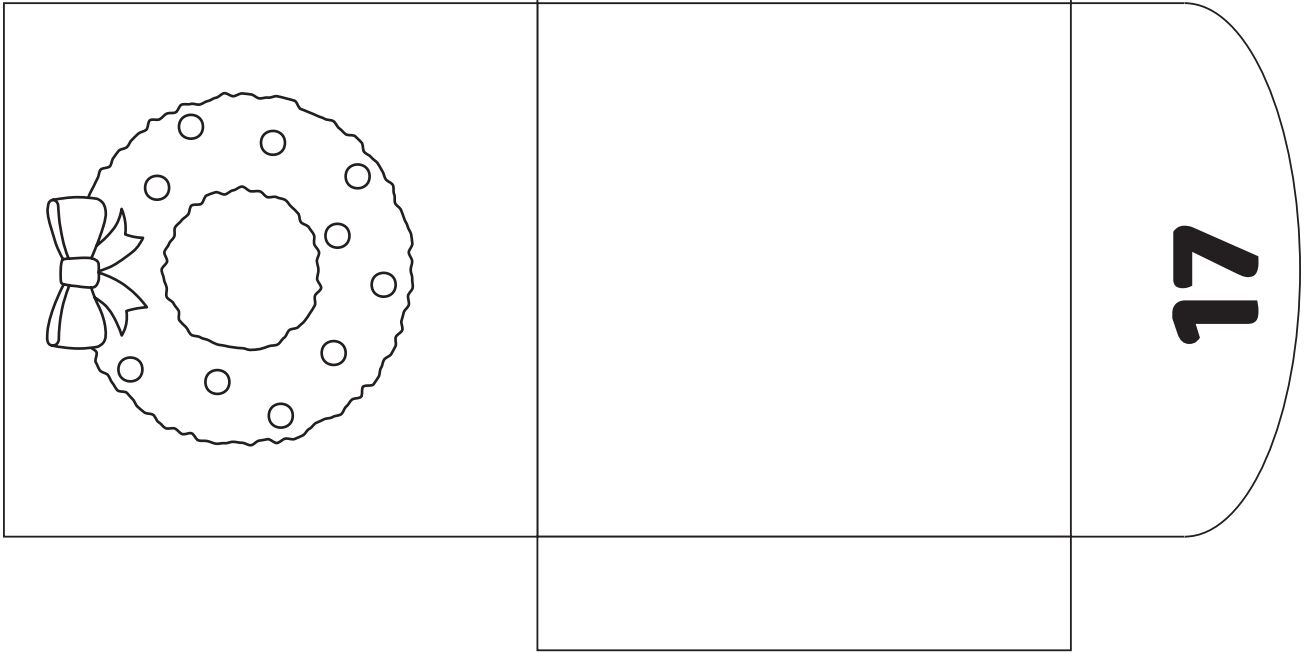

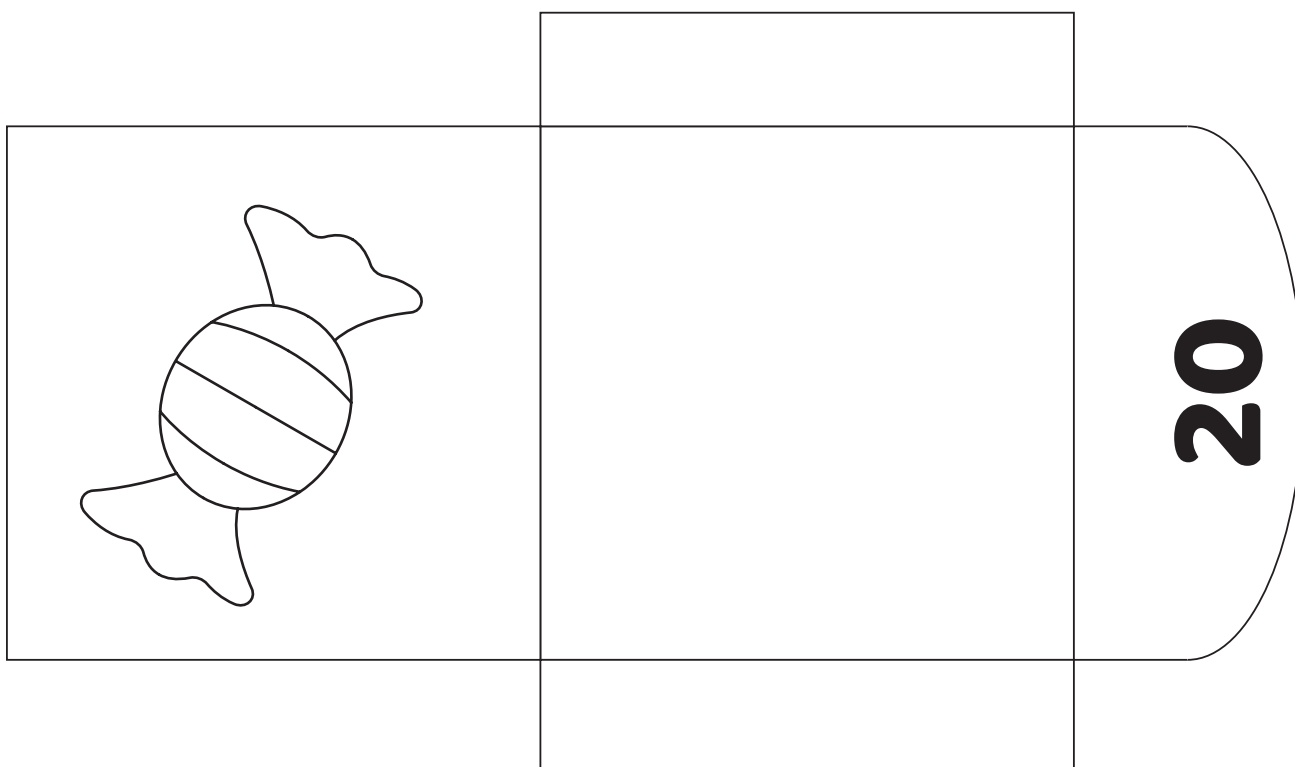
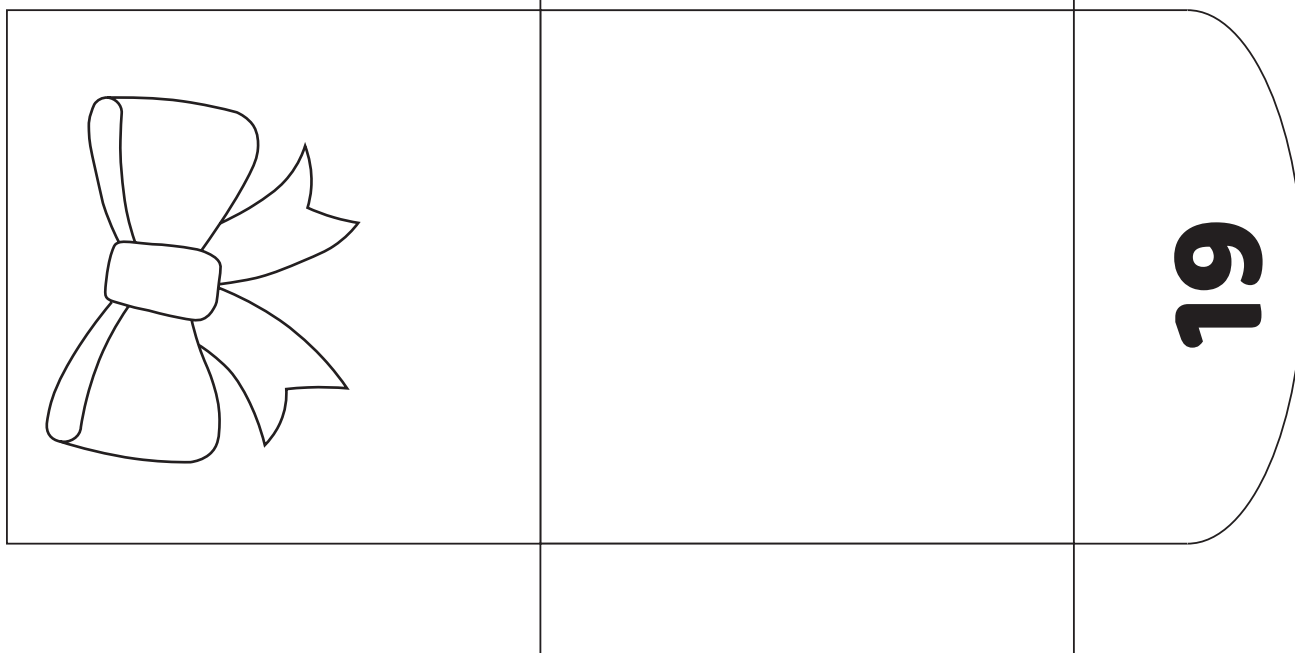

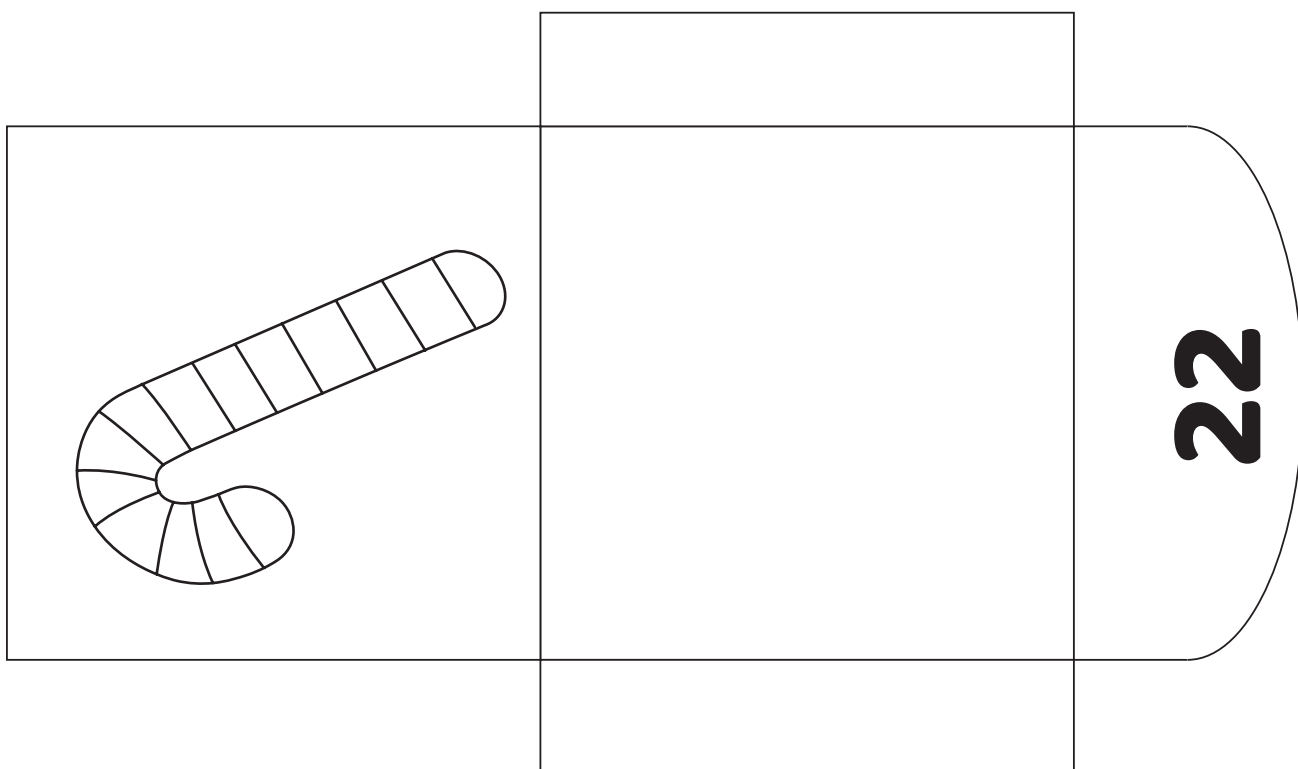
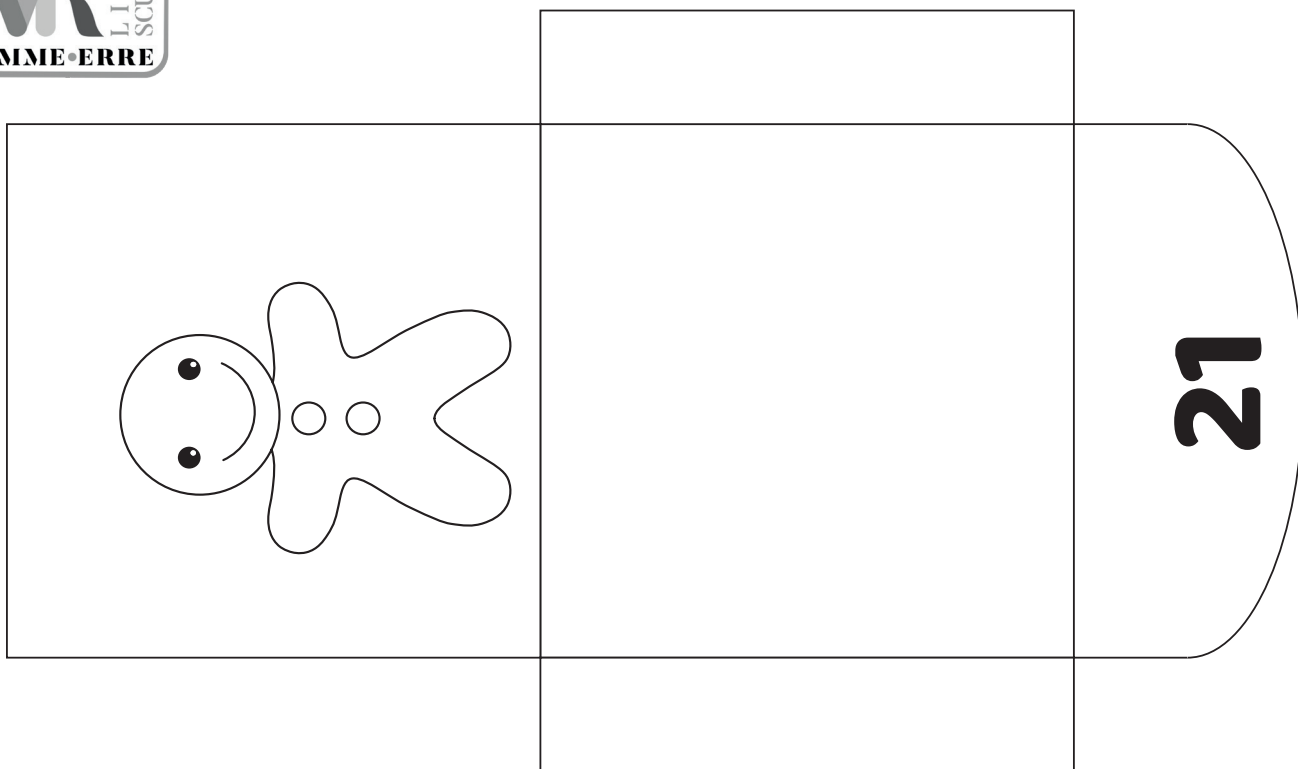

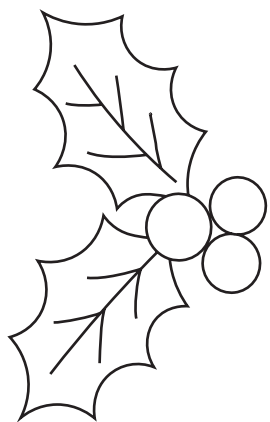

**23**

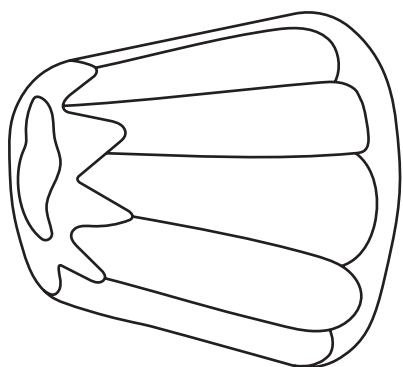

**24**

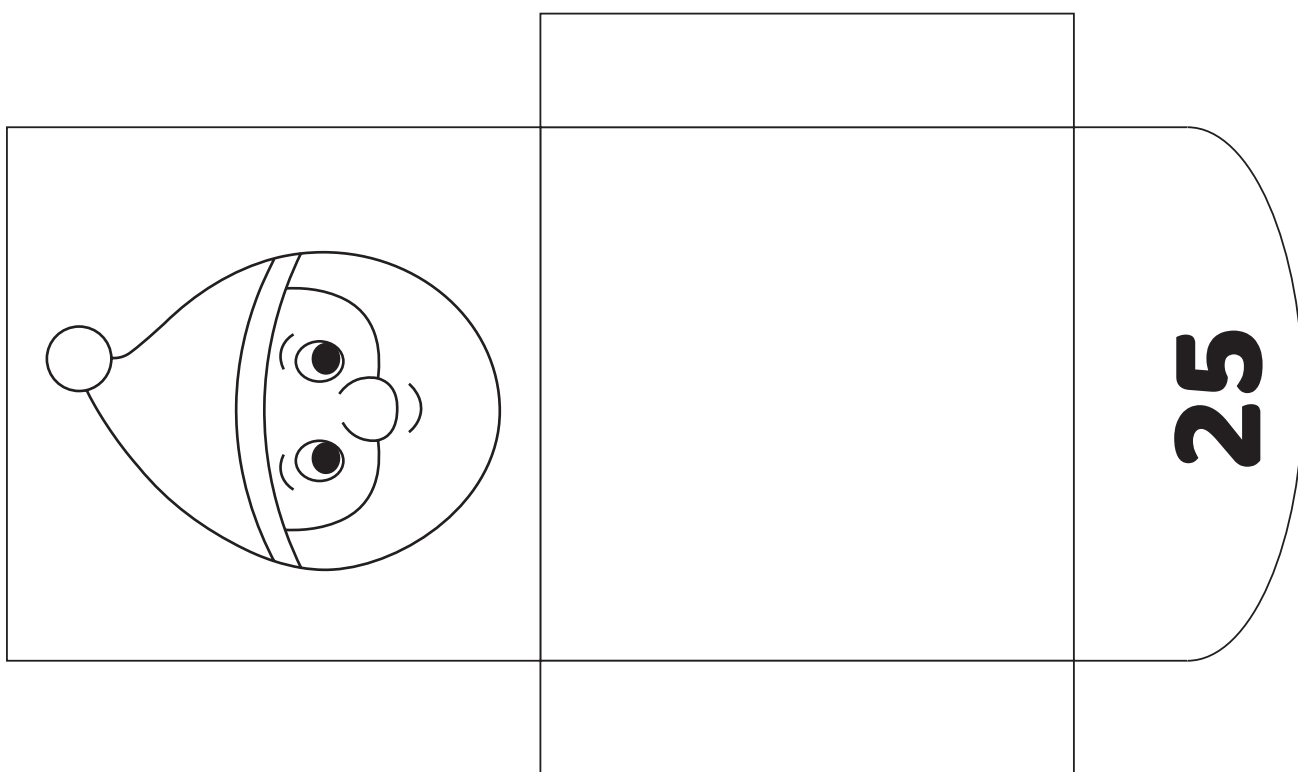

## LA CALZA DELLA BEFANA



COMPLETA LA CALZA DELLA BEFANA CON LA TECNICA CHE PREFERISCI.

## UN SIMPATICO PAGLIACCIO



INCOLLA DEI CORIANDOLI SUL VESTITO DEL PAGLIACCIO.